

REVISION HISTORY			
REV	DESCRIPTION	DATE	APPROVED

tanks are designed to be used in a horizontal position. rectangular tanks used in vertical position may require additional wall thickness or external support

tanks are not rated for gasoline or aromatic solvents

tank resins are fully uv stabilized

most size tanks are available in standard wall thickness shown or heavy duty

allow +/- 1% on tank dimensions for overall size variances

vent hole on tank will be welded shut if not used for fitting location

tank plastic resin is fda compliant based on manufacturer's specifications

tanks meet abyc and uscg requirements for marine water and holding tank applications

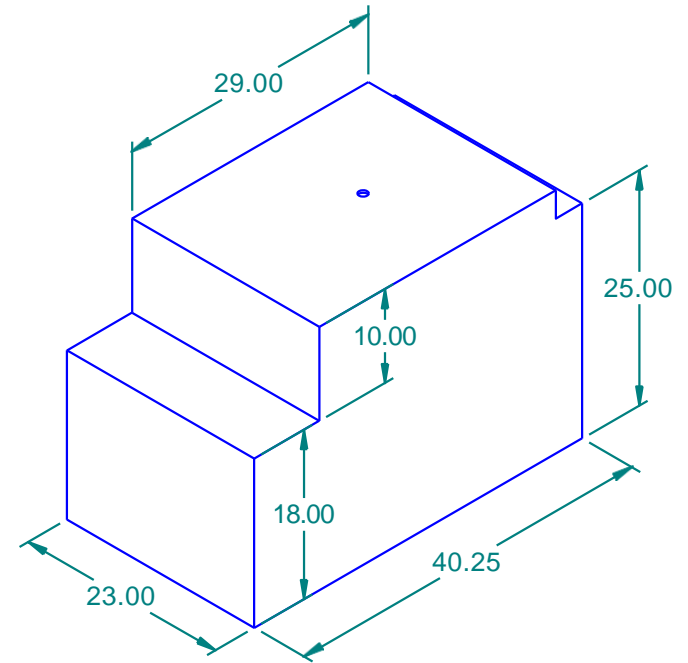
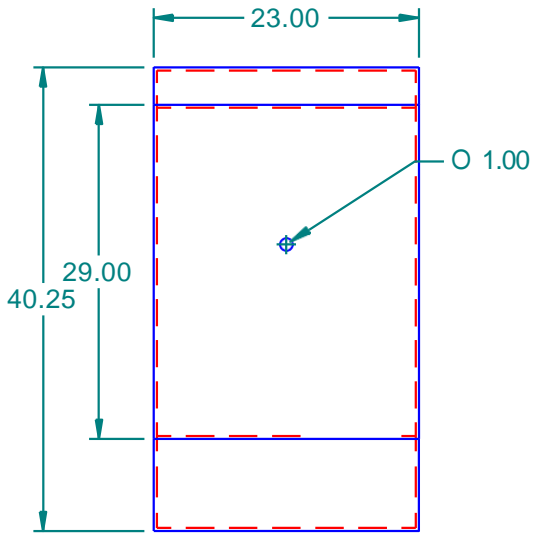

ISO View 300100

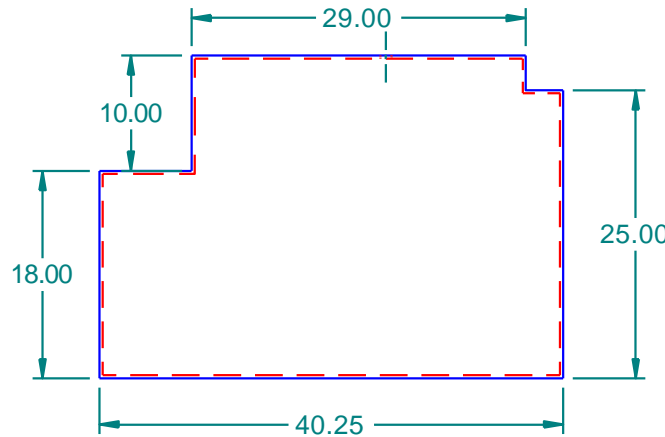
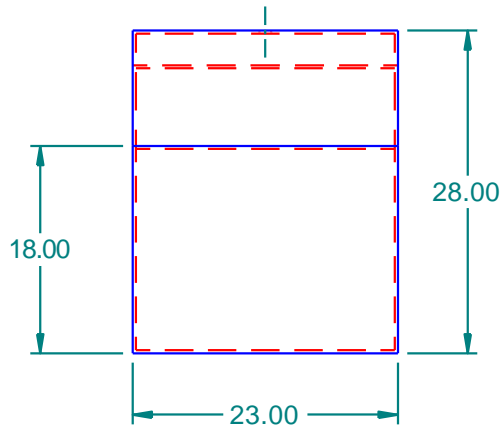

wall thickness: .265"

Tank Capacity: 100 Gallons



	NAME	DATE
DRAWN	mputt	4/30/2004
CHECKED		
ENG APPR		
MGR APPR		

16160 Hwy 27 Lake Wales, FL 33859

TITLE 100 Gallon Plastic Tank

SIZE	MATERIAL	REV
A	1 MDPE Natural	

FILE NAME: 300100.dft

PART#	WEIGHT	SHEET
300100	46.105 lbm	1 OF 1

UNLESS OTHERWISE SPECIFIED
DIMENSIONS ARE IN INCHES
ANGLES ±0.5°
2 PL ±0.125" 3 PL ±0.060"