

tanks are designed to be used in a horizontal position. rectangular tanks used in vertical position may require additional wall thickness or external support

tanks are not rated for gasoline or aromatic solvents

tank resins are fully uv stabilized

most size tanks are available in standard wall thickness shown or heavy duty

allow +/- 1% on tank dimensions for overall size variances

vent hole on tank will be welded shut if not used for fitting location

tank plastic resin is fda compliant based on manufacturer's specifications

tanks meet abyc and uscg requirements for marine water and holding tank applications

REVISION HISTORY

REV	DESCRIPTION	DATE	APPROVED

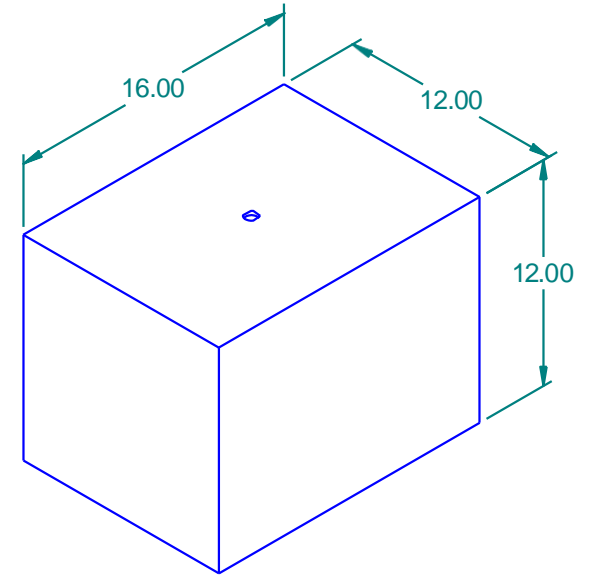

ISO View 207010

wall thickness: .235"

Tank Capacity: 9 Gallons

	NAME	DATE
DRAWN	mputt	1/25/2004
CHECKED		
ENG APPR		
MGR APPR		

		16160 Hwy 27 Lake Wales, FL 33859	
		TITLE 9 Gallon Plastic Tank	
SIZE A	MATERIAL 1MDPE Natural	REV	
FILE NAME: 207010.dft			
PART# 207010	WEIGHT 8.137 lbm	SHEET 1 OF 1	

UNLESS OTHERWISE SPECIFIED
DIMENSIONS ARE IN INCHES
ANGLES ± 0.5°
2 PL ± 0.125" 3 PL ± 0.060"