

TANKS ARE DESIGNED TO BE USED IN A HORIZONTAL POSITION. RECTANGULAR TANKS USED IN VERTICAL POSITION MAY REQUIRE ADDITIONAL WALL THICKNESS OR EXTERNAL SUPPORT

TANKS ARE NOT RATED FOR GASOLINE OR AROMATIC SOLVENTS

TANK RESINS ARE FULLY UV STABILIZED

MOST SIZE TANKS ARE AVAILABLE IN STANDARD WALL THICKNESS SHOWN OR HEAVY DUTY

ALLOW +/- 1% ON TANK DIMENSIONS FOR OVERALL SIZE VARIANCES

VENT HOLE ON TANK WILL BE WELDED SHUT IF NOT USED FOR FITTING LOCATION

TANK PLASTIC RESIN IS FDA COMPLIANT BASED ON MANUFACTURER'S SPECIFICATIONS

TANKS MEET ABYC AND USCG REQUIREMENTS FOR MARINE WATER AND HOLDING TANK APPLICATIONS

REVISION HISTORY			
REV	DESCRIPTION	DATE	APPROVED

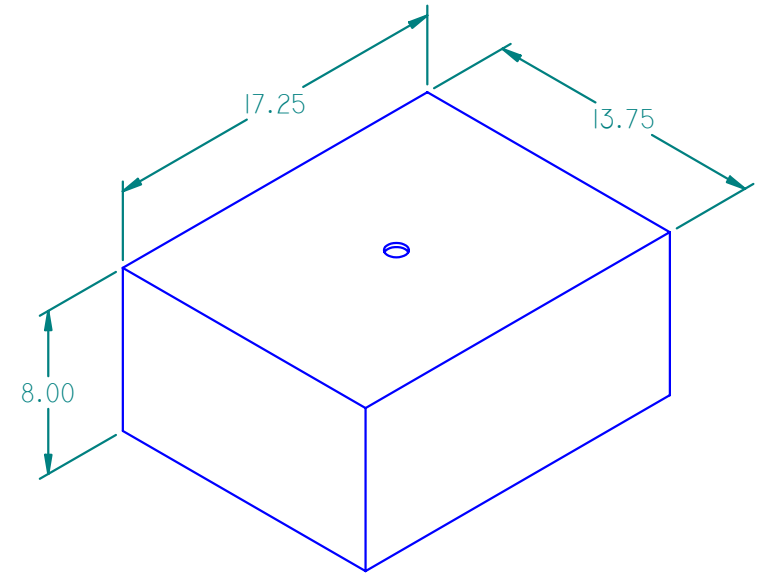

ISO VIEW 103008

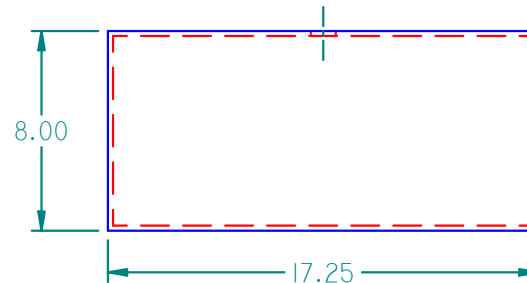

TANK CAPACITY: 8 GALLONS			 16160 Hwy 27 Lake Wales, FL 33859		
	NAME	DATE			
DRAWN	MPUTT	1/25/2004	TITLE 8 GALLON PLASTIC TANK		
CHECKED			SIZE A	MATERIAL: LMDPE NATURAL	
ENG APPR				REV	
MGR APPR			FILE NAME: 103008.DFT		
UNLESS OTHERWISE SPECIFIED DIMENSIONS ARE IN INCHES ANGLES ±0.5° 2 PL ±0.125" 3 PL ±0.060"			PART#: 103008	WEIGHT: 6.383 LBM	SHEET 1 OF 1

WALL THICKNESS: .200"