

REVISION HISTORY

REV	DESCRIPTION	DATE	APPROVED

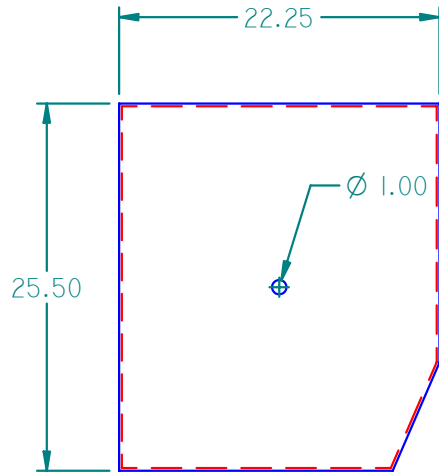

TANKS ARE DESIGNED TO BE USED IN A HORIZONTAL POSITION. RECTANGULAR TANKS USED IN VERTICAL POSITION MAY REQUIRE ADDITIONAL WALL THICKNESS OR EXTERNAL SUPPORT

TANKS ARE NOT RATED FOR GASOLINE OR AROMATIC SOLVENTS

TANK RESINS ARE FULLY UV STABILIZED

MOST SIZE TANKS ARE AVAILABLE IN STANDARD WALL THICKNESS SHOWN OR HEAVY DUTY

ALLOW +/- 1% ON TANK DIMENSIONS FOR OVERALL SIZE VARIANCES

VENT HOLE ON TANK WILL BE WELDED SHUT IF NOT USED FOR FITTING LOCATION

TANK PLASTIC RESIN IS FDA COMPLIANT BASED ON MANUFACTURER'S SPECIFICATIONS

TANKS MEET ABYC AND USCG REQUIREMENTS FOR MARINE WATER AND HOLDING TANK APPLICATIONS

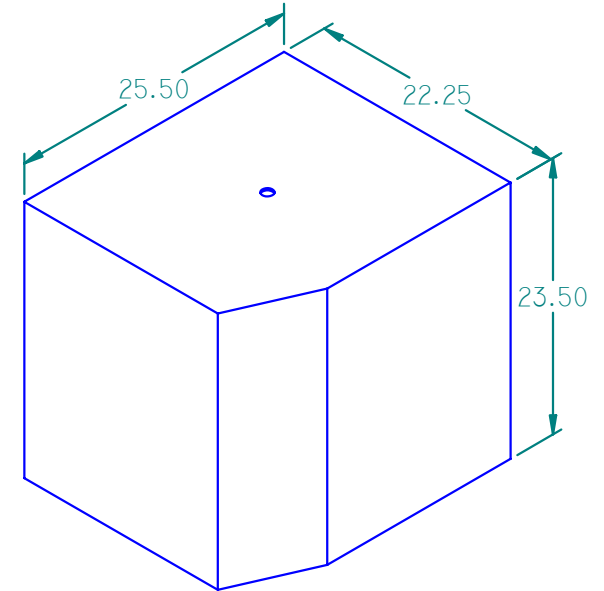

ISO VIEW 209051

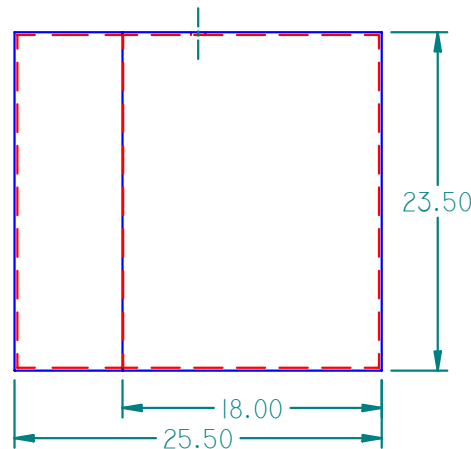
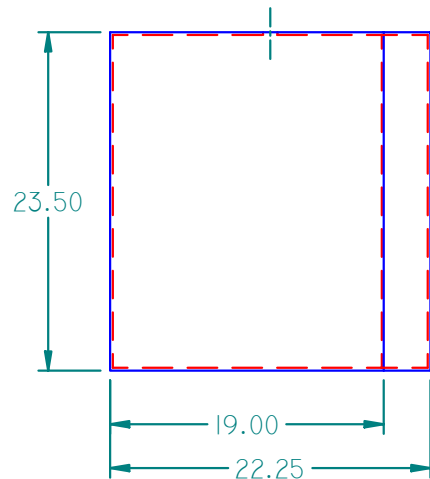

TANK CAPACITY: 54 GALLONS

	NAME	DATE
DRAWN	MPUTT	1/26/2004
CHECKED		
ENG APPR		
MGR APPR		



16160 Hwy 27 Lake Wales, FL 33859

TITLE		54 GALLON PLASTIC TANK	
SIZE	A	MATERIAL: LMDPE NATURAL	REV

FILE NAME: 209051.DFT

WALL THICKNESS: .191"

UNLESS OTHERWISE SPECIFIED  
DIMENSIONS ARE IN INCHES  
ANGLES ±0.5°  
2 PL ±0.125" 3 PL ±0.060"

PART#: 209051	WEIGHT: 21.045 LBM	SHEET 1 OF 1
---------------	--------------------	--------------