

Plastic resin is fully FDA compliant based upon manufacturer's specifications

Resins are fully UV stabilized

Allow +/- 1% on dimensions for overall size variances

REVISION HISTORY

REV	DESCRIPTION	DATE	APPROVED

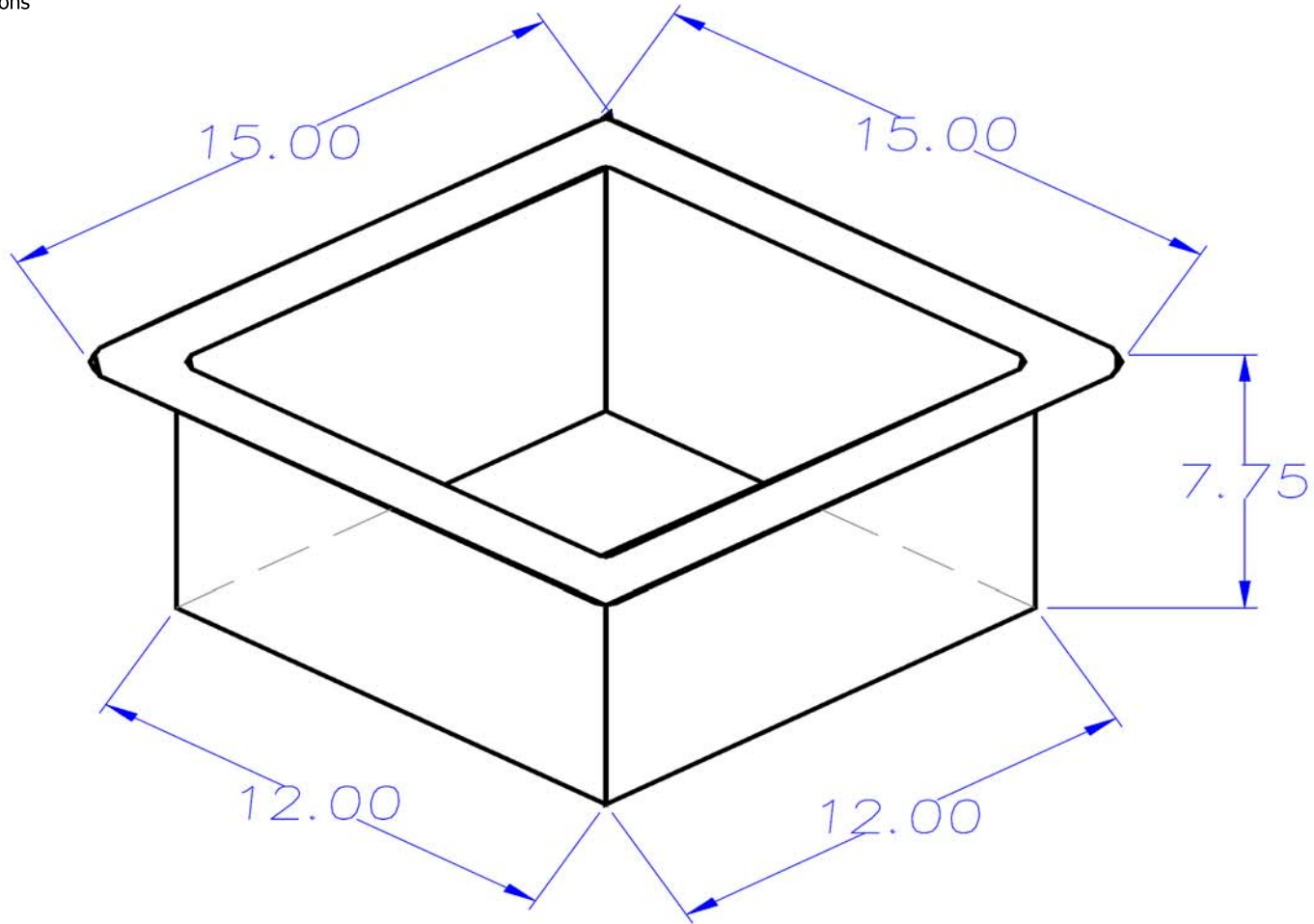

Note: Cooler adds 1/2" Urethane insulation increasing base dimensions and total weight

Wall Thickness: 0.125

Capacity: 4 Gallons		
	NAME	DATE
DRAWN	MPUTT	9/01/2004
CHECKED		
ENG APPR		
MGR APPR		

UNLESS OTHERWISE SPECIFIED
DIMENSIONS ARE IN INCHES
ANGLES ±0.5°
2 PL ±0.125° 3 PL ±0.060°

Dura-Cast Products INC.
Rotomolding Plastic for the Future
16160 Hwy 27 Lake Wales, FL 33859
800.683.4116 863.638.3200 F 863.638.2443
www.duracast.com

TITLE Bin or Cooler with Urethane Insulation		
SIZE A	MATERIAL: Cmpd White Polyethylene	REV
Part #: 103713		
WEIGHT: 4#		SHEET 1 OF 1